

NECK DETAIL:
SCALE 2:1

Pitch = 9mm
Turns = 0.356 (128°) without
start and end
of thread
Starts= 3

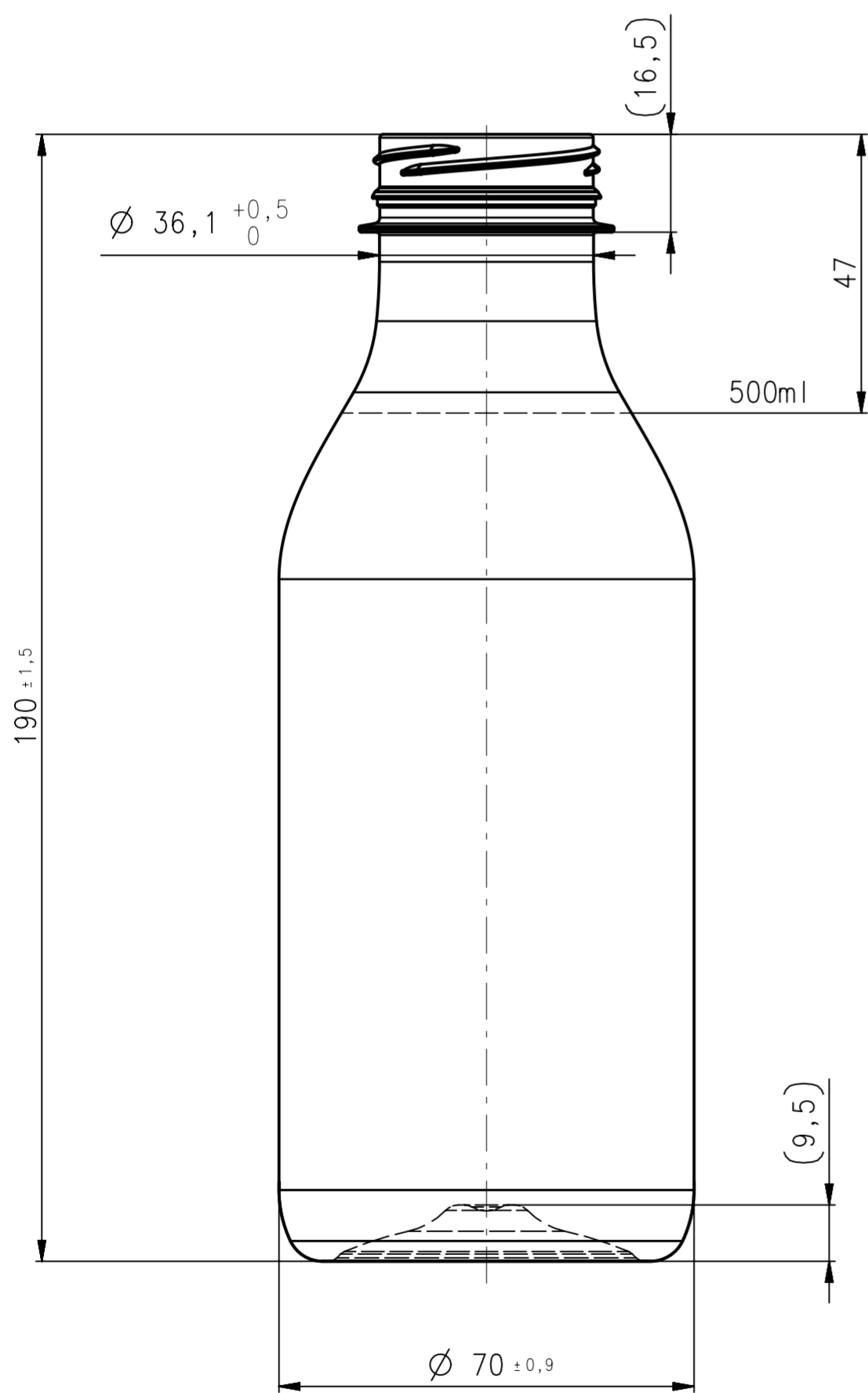
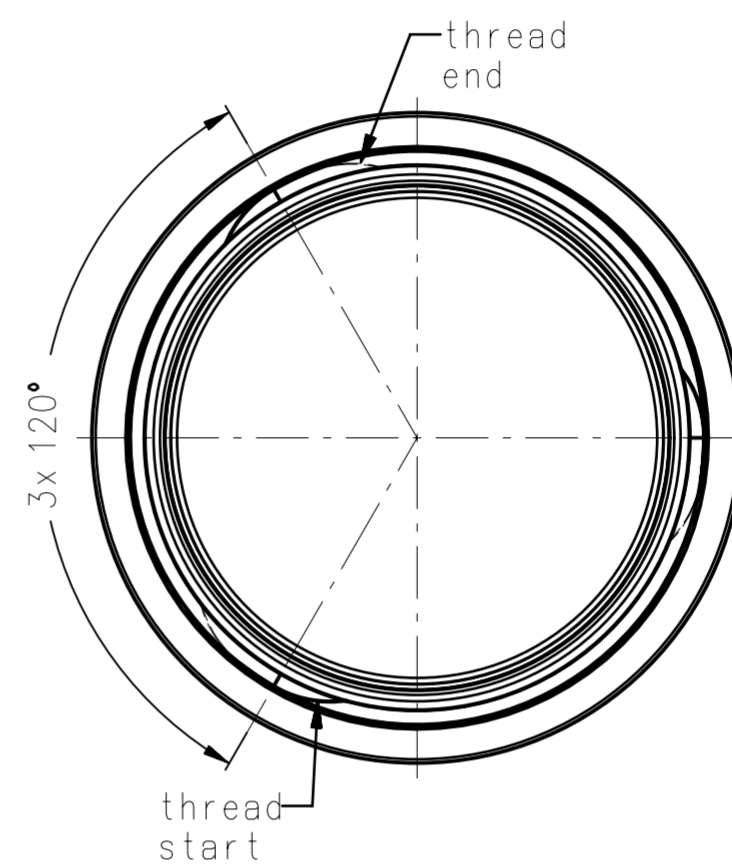
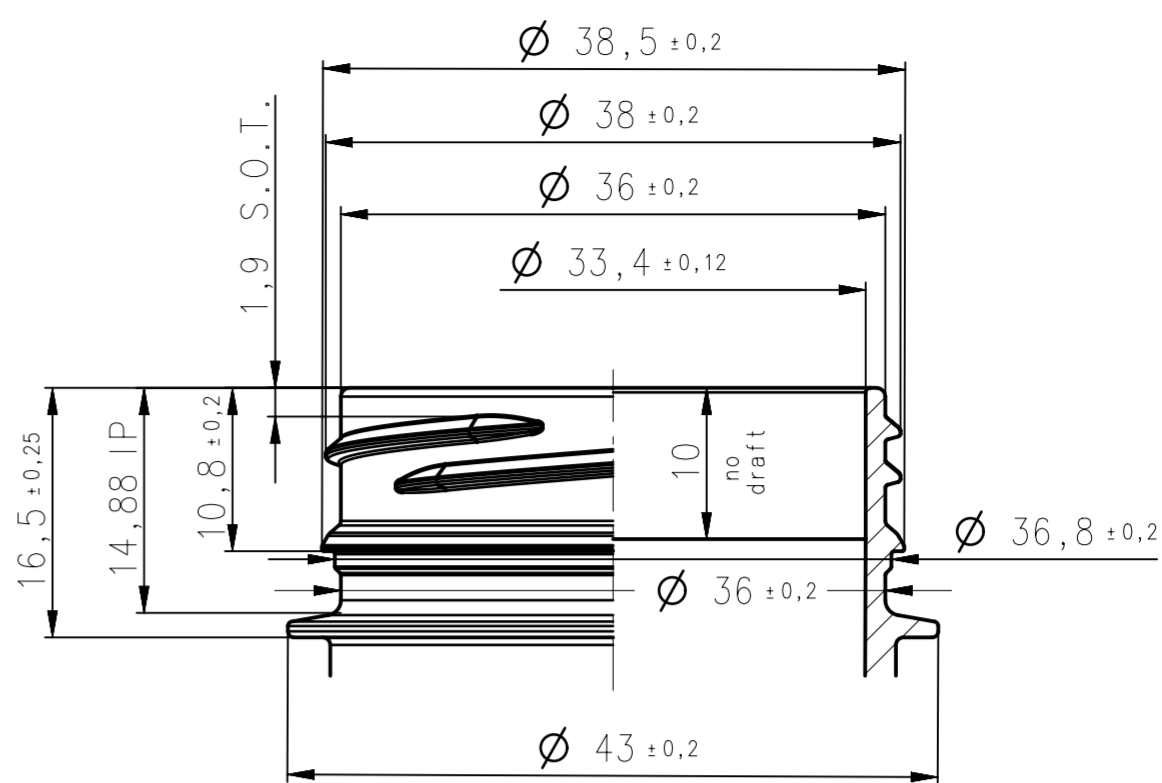
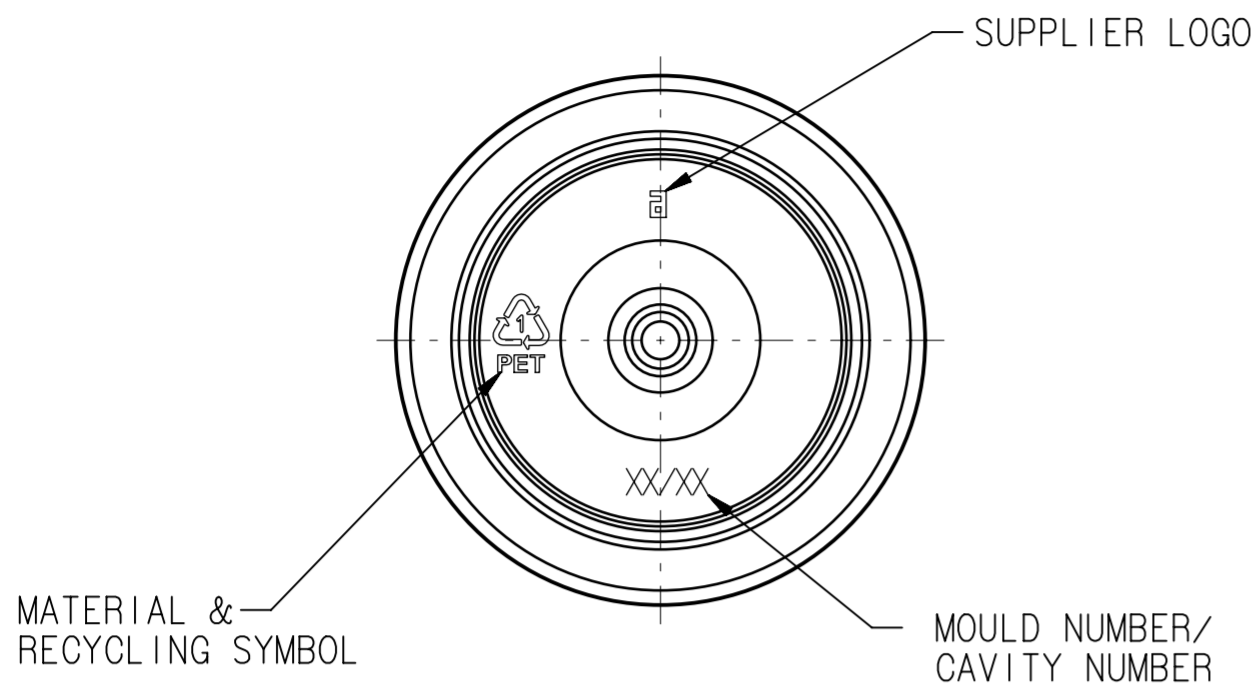

MATERIAL: PET
WEIGHT: 28 ± 1g
VOLUME: 550 ± 15ml BRIMFULL

STRETCHED LENGTH: 210.89mm
AVERAGE CIRCUMFERENCE: 219.91mm
BASE CIRCUMFERENCE: 173.72mm

Index		Modification:		Name	Date	Index		Modification:		Name	Date
Scale:		1:1		Name	Date	ALPLA reserves all rights to the technical IP contained in the document		Superseded:			
2:1				Prepared: Mudassar Ahmed	13.Jan.21	Superseded by:		Weight: kg		Art.No.:	
				Reviewed: KJ	13.Jan.21					Page: 1 of 1	
Title:		Milk bottle 500ml PET		Drawing No.:		9401_021_003_01		Revision:		00	

ALPLA