

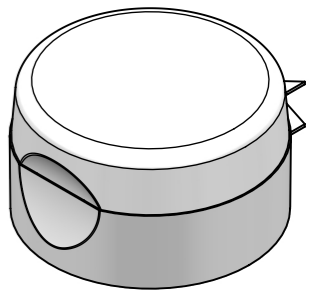

SECTION A-A
SCALE 3:1

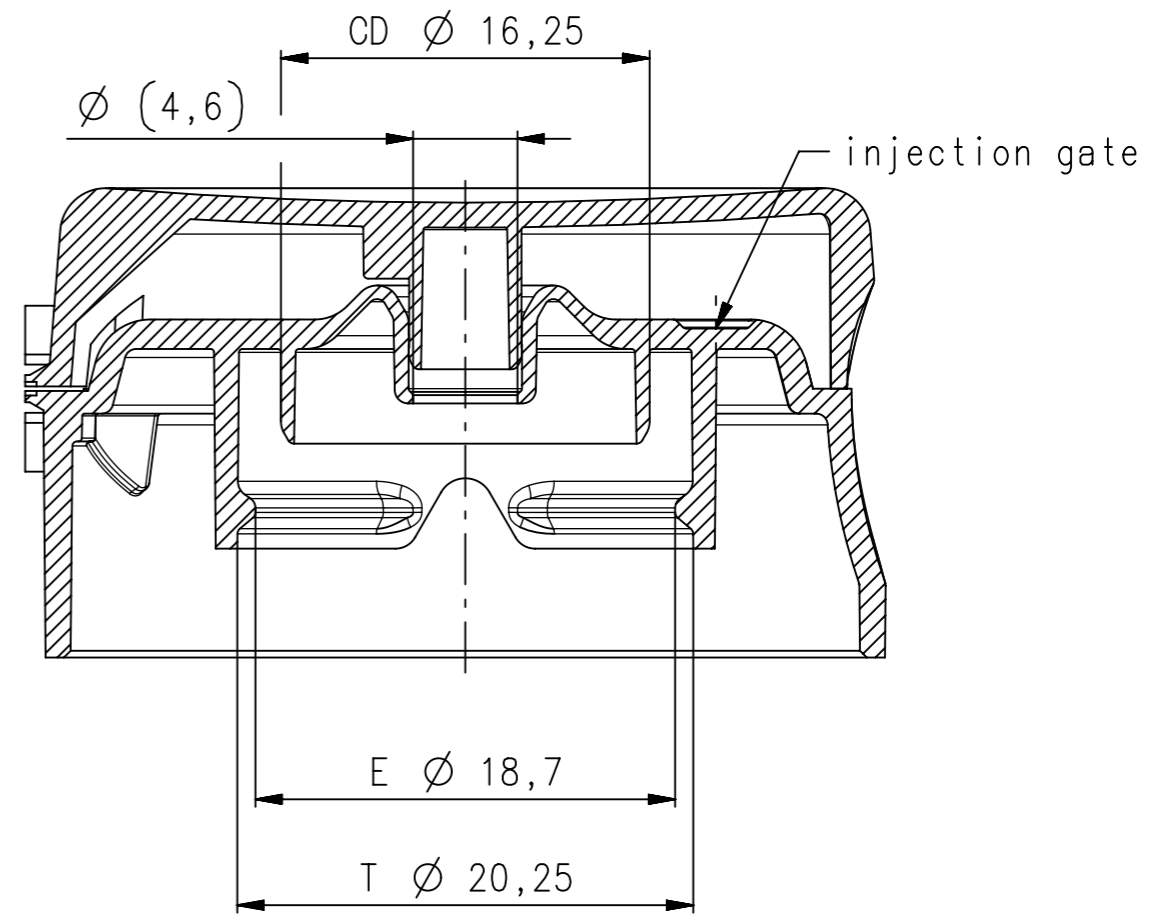

File reference:
9301_916_003_03_R01.pdf

Note: hinge in closed position equates not to reality

Index	Modification:	Name	Date	Index	Modification:	Name	Date
-	-	-	-	-	-	-	-
Scale: 2:1 1:1/3:1		Name Prepared: Suess Georg	Date 04.Aug.21				
ALPLA reserves all rights to the technical IP contained in the document		Superseded: Superseded by: Weight: 0.00kg					
Title: ASC FCR Flip cap 40mm for tubes				Art.No.:		Page: 1 of 1	
				Drawing No.:		Revision: 00	
				9301_021_135_01_C1			